

BEHRINGER®

BSO92S06N25 Data Sheet

Dimensional Data:

Length 5.50 IN
OD (Top): 3.62 IN
OD (Bottom): 3.62 IN
Thread: 1 – 12 UNF



Performance Data:

Micron Rating: 6.00 Nominal
Maximum Temperature: 225 °F
Flow Direction: Out to In
Recommended Change Out: 20 PSID
By-Pass: None

Physical Specifications:

Media: Paper
Seal Material: Buna
Adhesive: Epoxy
Material: Drawn Steel Can
Configuration: SOE

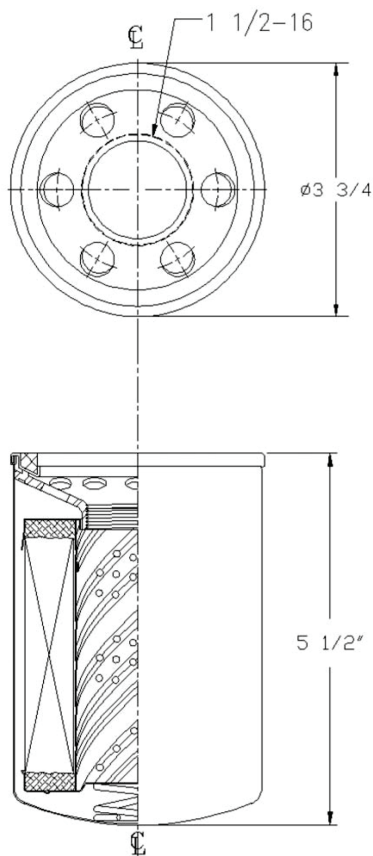

Operating Pressure:	225 PSI
Operating Temp:	-65° F to 250° F
Collapse Rating:	80 PSID MAX
Thread Size:	1 1/2-16
Filtration Rating:	B ₁ = 200
Seal Materials:	Buna Gasket
Gasket ID:	2-21/32"
Gasket OD:	3-15/32"